

# Data Sheet



Article number: 588Q2C424XE0671

Description: Solenoid valve type Q2C424.XE0.671 2/2 NC  
24 VDC orifice 2,4 housing in Stainless AISI 316 Inlet port G1/4"

## Measures

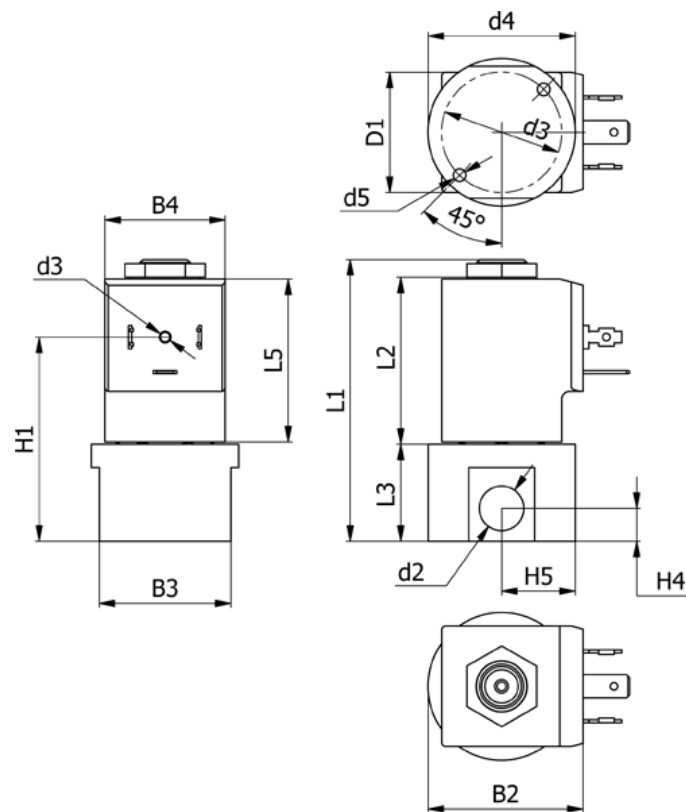

B2 = 40	H1 = 52.5
B3 = 34	H4 = 8.5
B4 = 31	H5 = 19
d2 = G1/4"	L1 = 72.6
d3 = M3x4	L3 = 25
d4 = 31	L5 = 42.5
d5 = M4x8	Orifice = 2.4
Flow = 3.5	Valve function = 2/2 NC

Voltage = 24 VDC